

ARMÁRIO AÉREO 01 PORTA BÁSCULA ADEGA BARONESA/IMPERATRIZ 120 CM 100% MDF

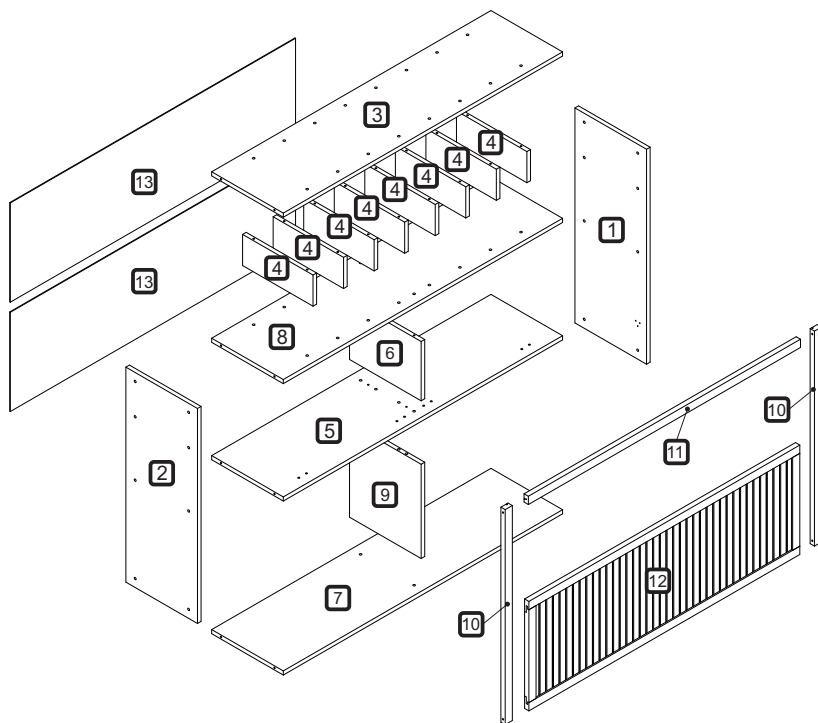

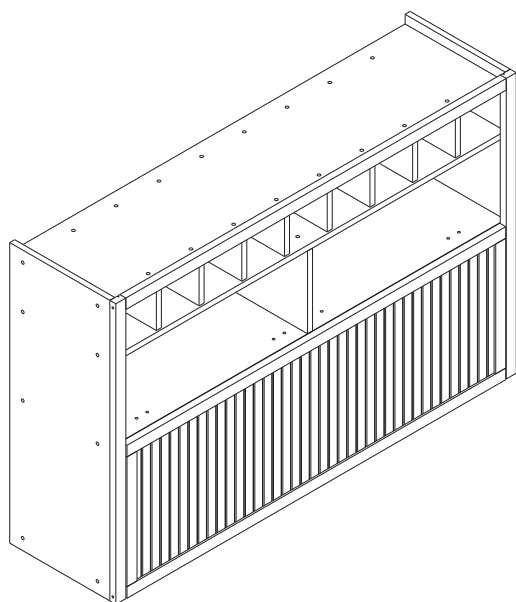

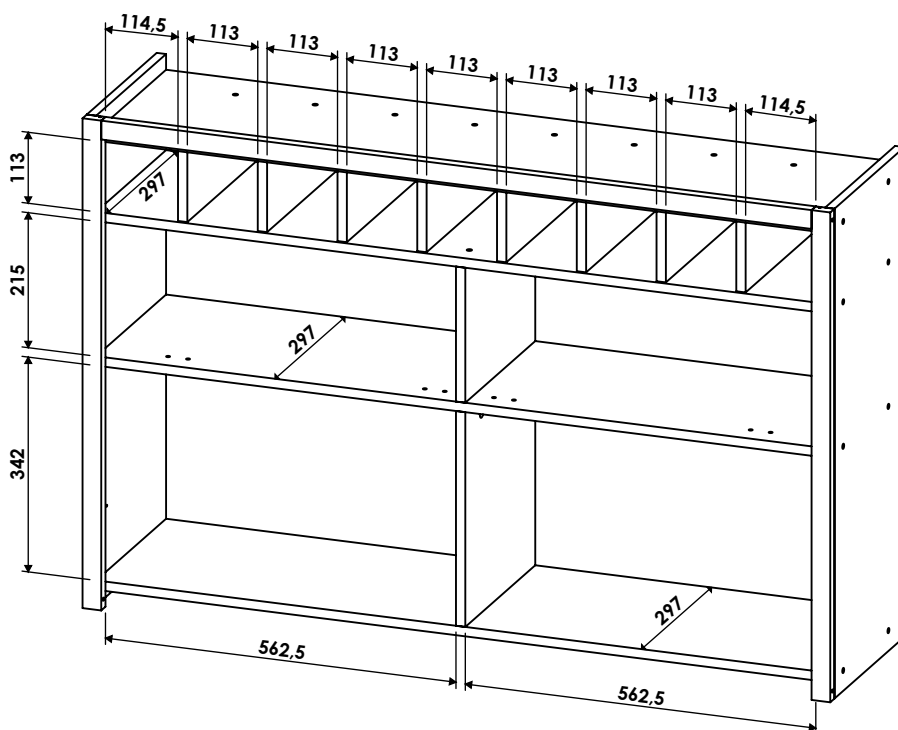

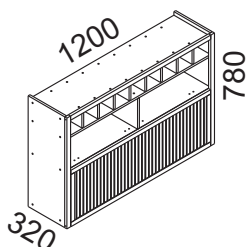



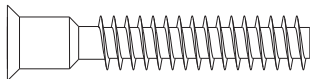
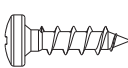
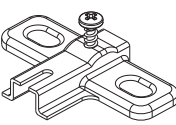
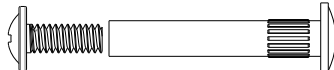
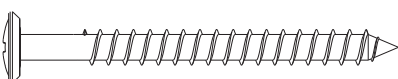

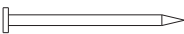
DIMENSÕES DOS ESPAÇOS INTERNOS (MEDIDAS EM MILÍMETRO)

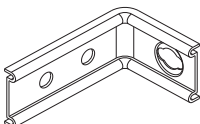
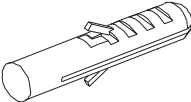
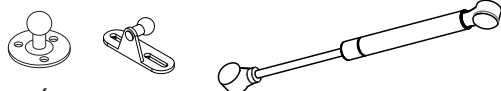
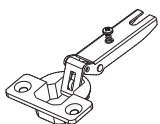
DIMENSÕES MÁXIMAS DO PRODUTO MONTADO

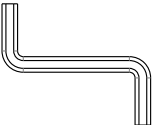

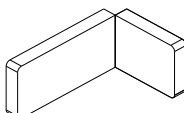
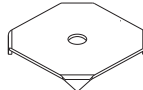
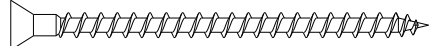
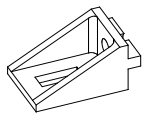
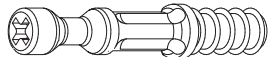
CÓDIGO	DESCRIÇÃO	QTDE	COMP.	LARG.	ESP.
1	LATERAL DIREITA	1	780	297	15
2	LATERAL ESQUERDA	1	780	297	15
3	TAMPO	1	1.170	297	15
4	DIVISÃO DE NICHOS	8	113	292	15
5	PRATELEIRA INFERIOR	1	1.170	297	15
6	DIVISÃO SUPERIOR	1	215	297	15
7	BASE	1	1.170	297	15
8	PRATELEIRA DE NICHOS	1	1.170	297	15
9	DIVISÃO INFERIOR	1	342	297	15
10	MOLDURA LATERAL	2	780	30	18
11	MOLDURA SUPERIOR	1	1.140	30	18
12	PORTA BASCULANTE	1	1.135	397	18
13	FUNDO TRASEIRO	2	1.195	363	2,5

CÓDIGO/DESCRIÇÃO	QUANTIDADE	CÓDIGO/DESCRIÇÃO	QUANTIDADE
A  PARAFUSO 7x40mm CABEÇA CHATA	54	B  PARAFUSO 4x14mm CABEÇA PANELA	38
C  CALÇO PARA DOBRADIÇA 35mm	3	D  PARAFUSO UNIAO DE MÓDULOS 28MM	3
E  PARAFUSO 5x50mm CABEÇA FLANGEADA	4	F  CAVILHA 8x30mm	2
G  PREGO 10x10 COM CABEÇA	50	H  PARAFUSO DE UNIÃO 17mm	6
I  CANTONEIRA METALICA PARA FIXAÇÃO NA PAREDE	4	J  BUCHA DE PAREDE DE 8mm	4
K  PISTÃO A GÁS 60N	2	L  DOBRADIÇA RETA CANECO 35mm	3
M  BATENTE DE SILICONE	2	N  CHAVE ZETA	1
O  TAPA FURO ADESIVO 12mm	42	P  CAPA PLÁSTICA PARA CANTONEIRA	4
Q  FIXADOR FUNDO TRASEIRO METÁLICO	12	R  PARAFUSO 3,5X50mm CABEÇA CHATA	2
S  SUPORTE ANGULAR	10	T  PARAFUSO MINIFIX	2
U  TAMBOR MINIFIX	2	V  TAMPA MINIFIX	2